

TROUBLESHOOTING

NOTICE:

When replacing the internal mechanism (computer part) of the audio system, be careful that no part of your body or clothing comes in contact with the terminals of the leads from the IC, etc. of the replacement part (spare part).

HINT:

This inspection procedure is a simple troubleshooting which should be carried out on the vehicle during system operation and was prepared on the assumption of system component troubles (except for the wires and connectors, etc.).

Always inspect the part with trouble taking the following items into consideration.

- Open or short circuit of the wire harness
- Connector or terminal connection fault

	Problem	No.
Radio	Radio not operating when power switch turned to "ON".	1
	Display indicates when power switch turned to "ON", but no sound (including "noise") is produced.	2
	Noise present, but AM – FM not operating.	3
	Any speaker does not work.	4
	Any AM or FM does not work.	5
	Few preset turning bands.	5
	Reception poor.	6
	Sound quality poor.	7
Tape player	Preset memory erased.	8
	Cassette tape cannot be inserted.	9
	Cassette tape inserted, but no power.	10
	Power coming in, but tape player not operating.	11
	Any speaker does not work.	12
	Sound quality poor.	13
	Tape jammed, malfunction with tape speed or auto–reverse.	14
CD player	Cassette tape will not eject.	15
	CD cannot be inserted.	16
	CD inserted, but no power.	17
	Power coming in, but CD player not operating.	18
	Sound jumps.	19
	Sound quality poor (Volume faint).	20
	Any speaker does not work.	21
Power amplifier	CD will not be ejected.	22
	No power coming in.	23
	Power coming in, but power amplifier not operating.	24
	Any speaker does not work.	25
Noise	Noise occurs	26
	Noise produced by vibration or shock while driving.	27
	Noise produced when engine starts.	28

The term "AM" includes LW, MW and SW, and the term "FM" includes UKW.

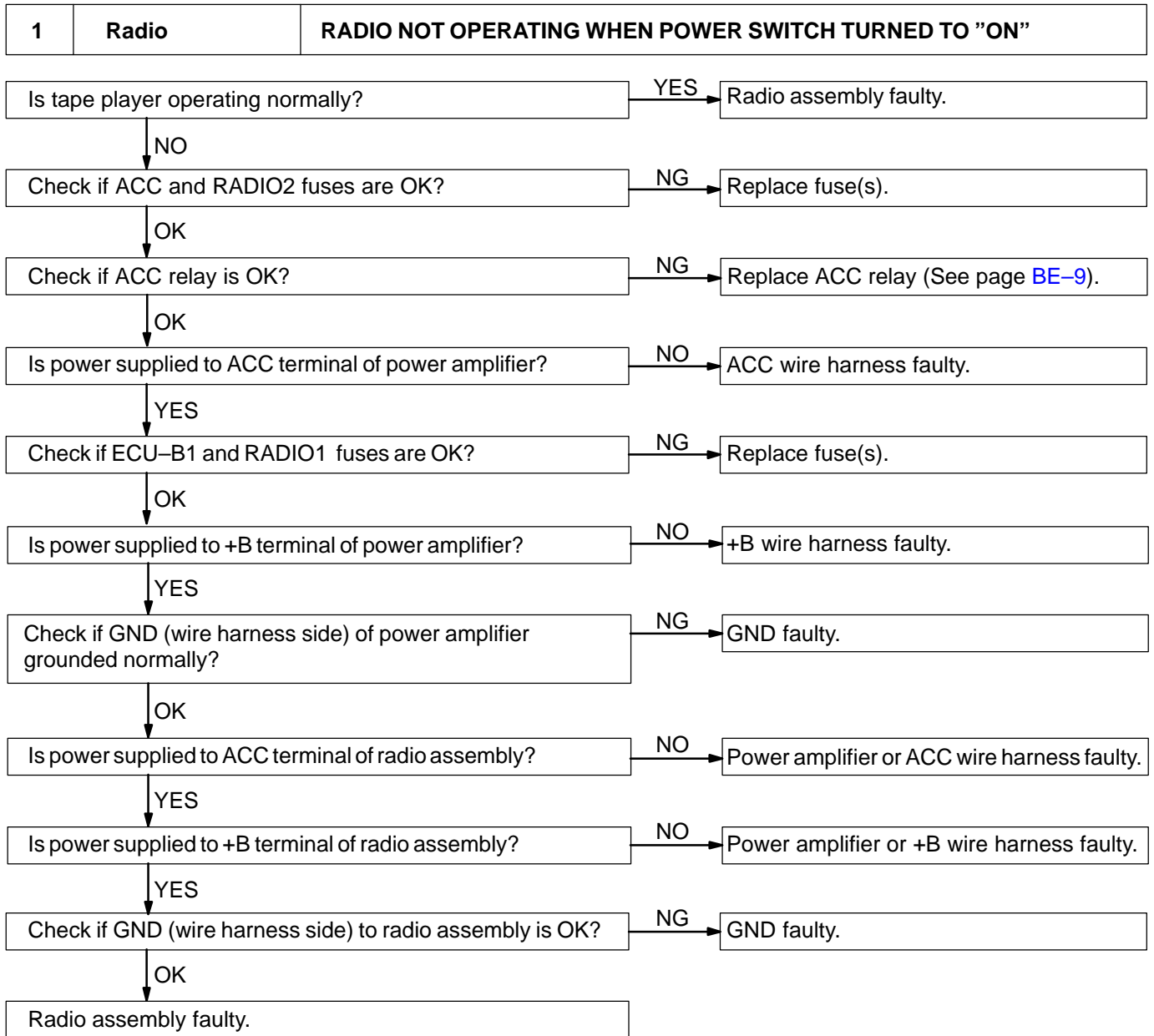

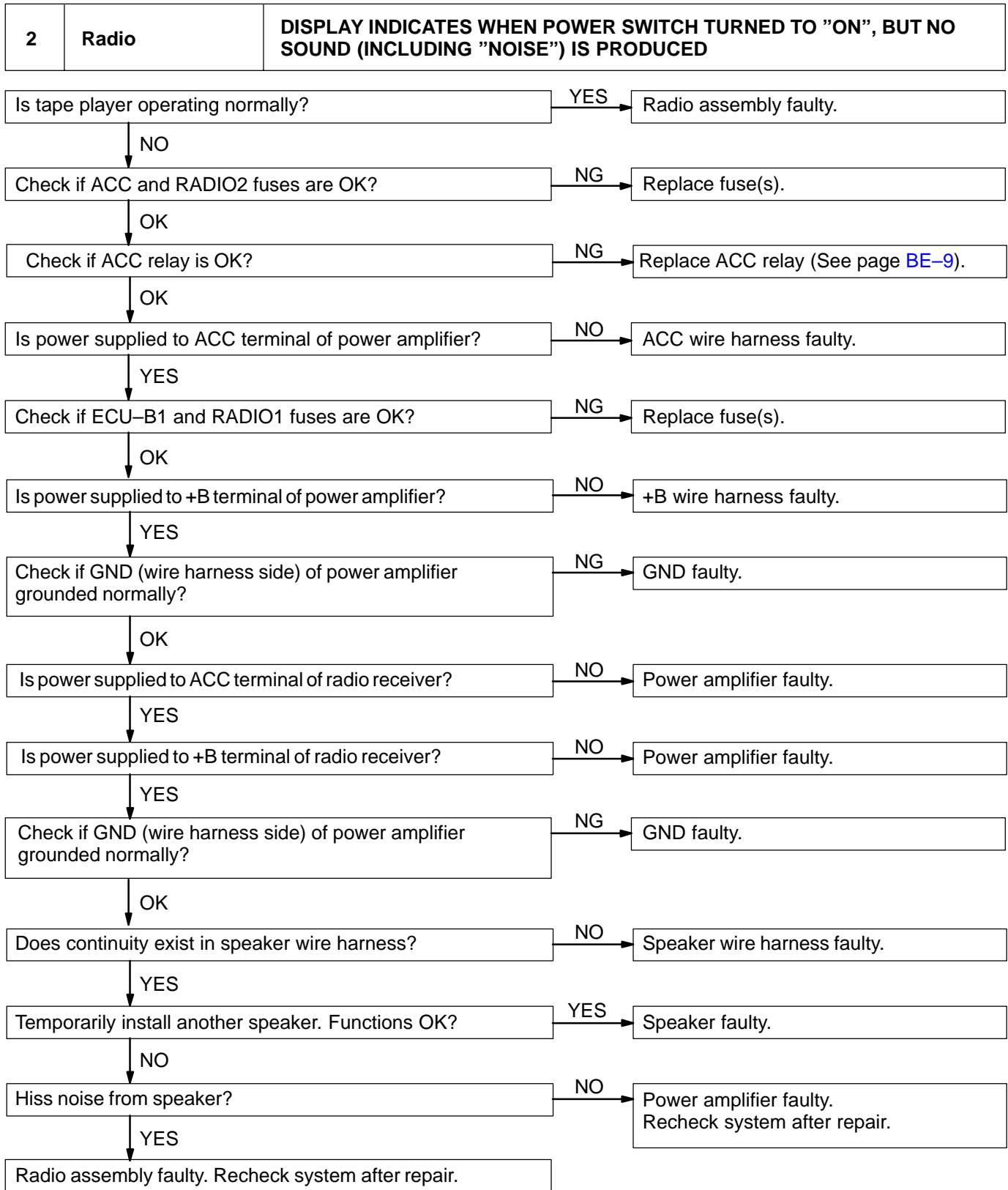

3	Radio	NOISE PRESENT, BUT AM-FM NOT OPERATING
----------	--------------	---

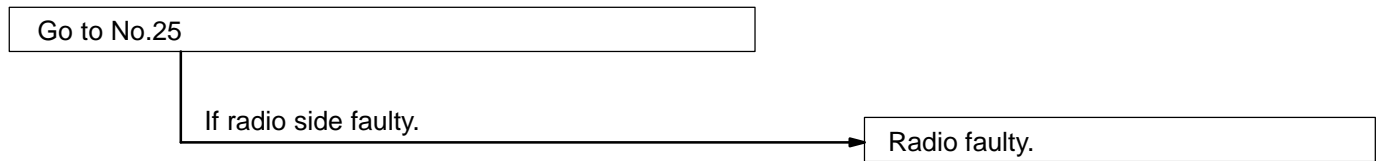

4	Radio	ANY SPEAKER DOSE NOT WORK
----------	--------------	----------------------------------

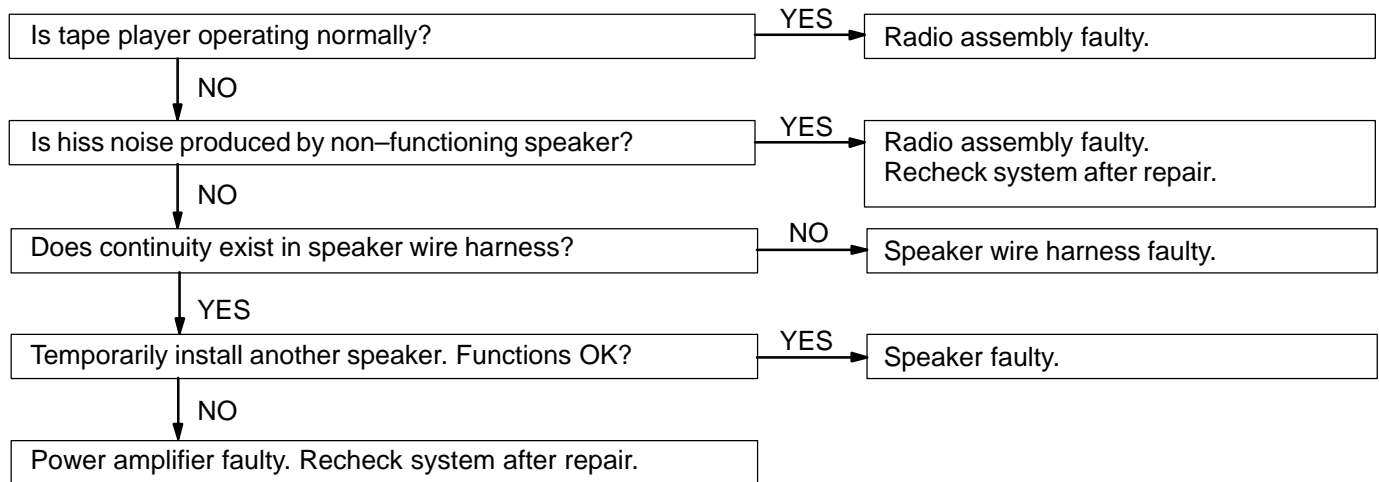

5	Radio	ANY AM OR FM DOES NOT WORK FEW PRESET TUNING BANDS
----------	--------------	---

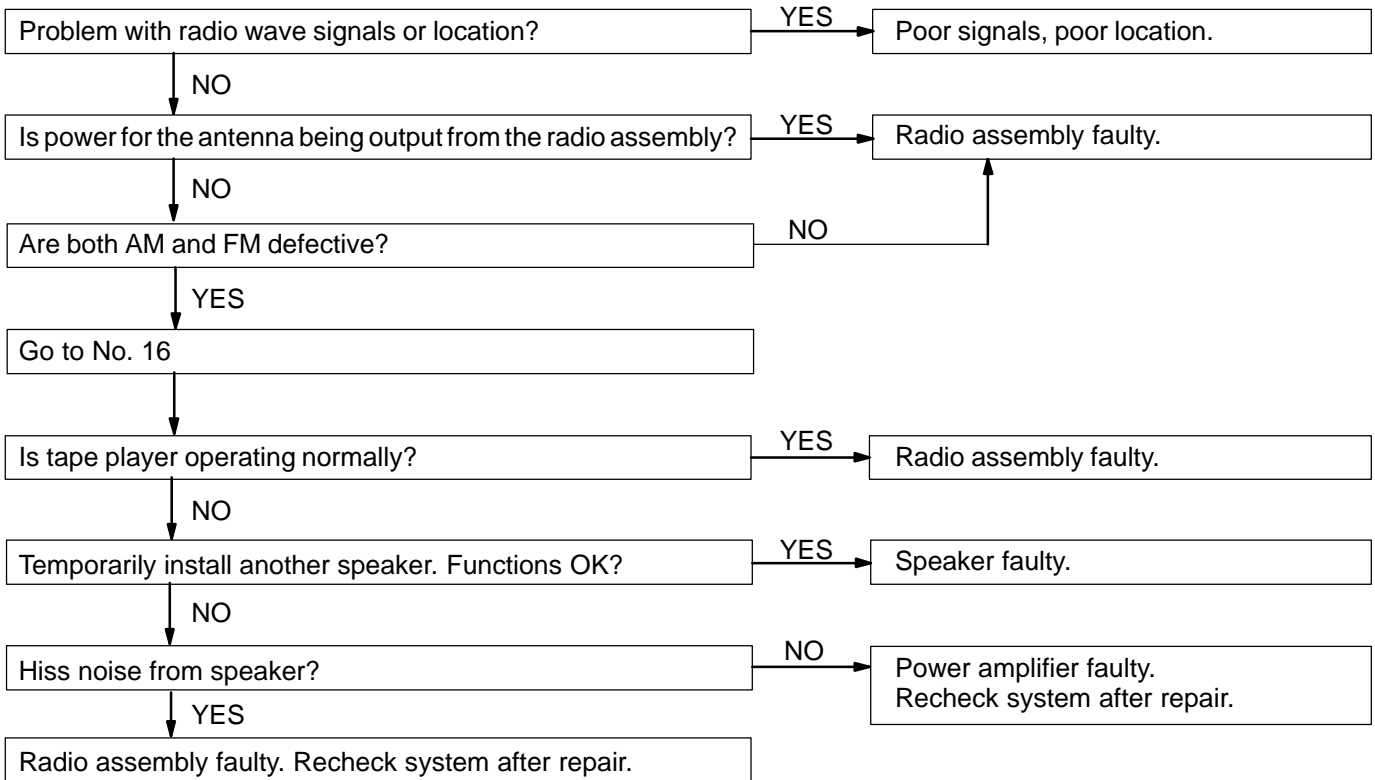

6	Radio	POOR RECEPTION
----------	--------------	-----------------------

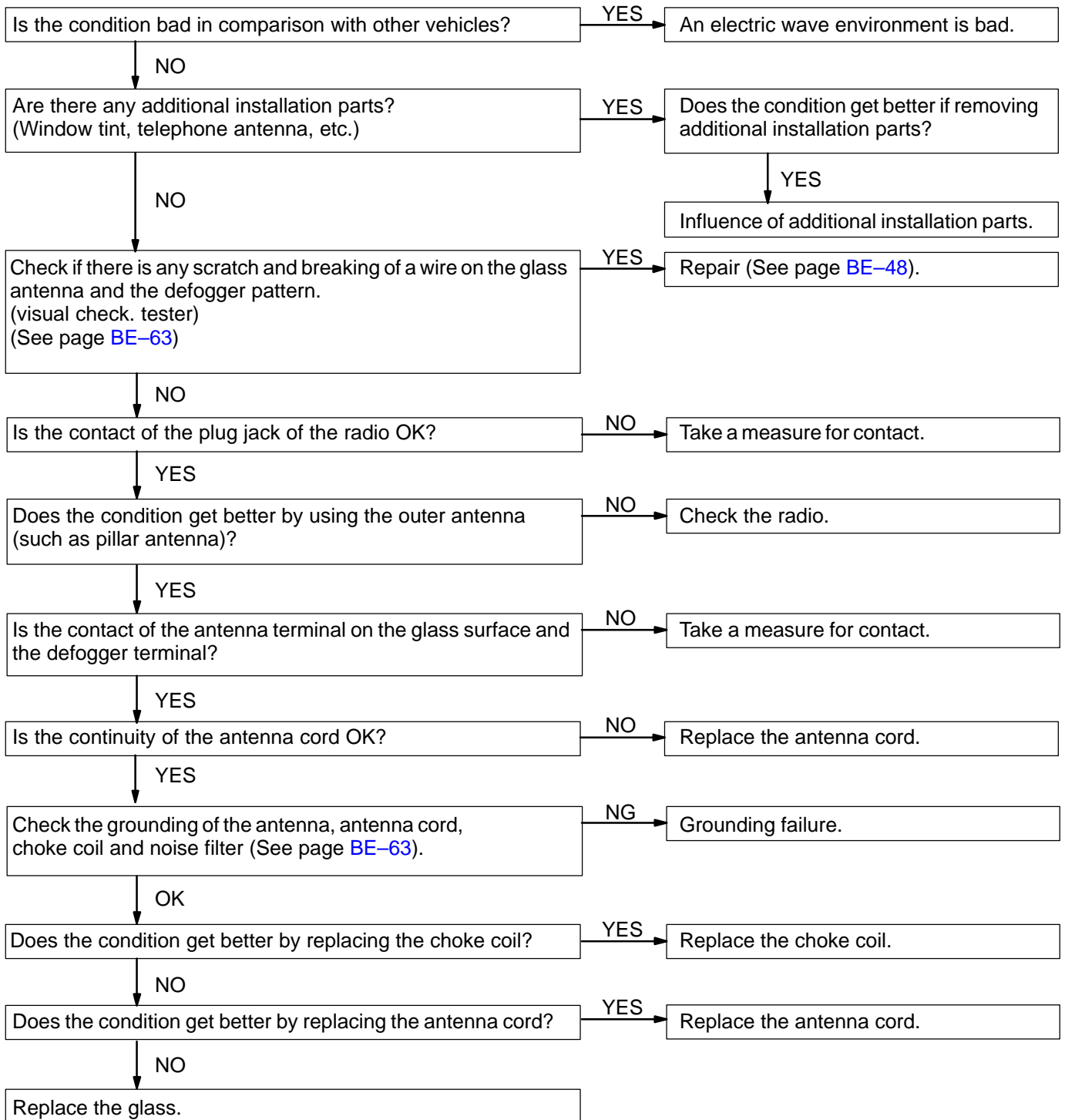

7	Radio	SOUND QUALITY POOR
----------	--------------	---------------------------

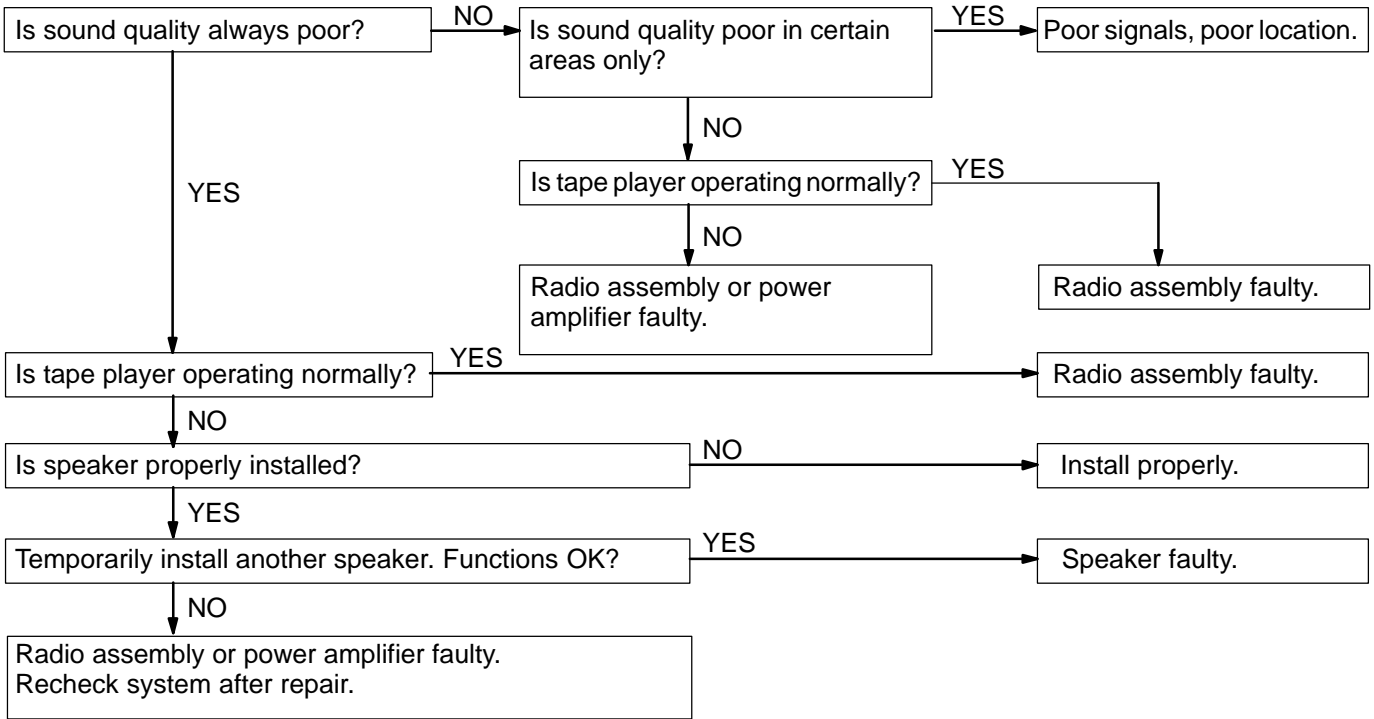

8	Radio	PRESET MEMORY DISAPPEARS
----------	--------------	---------------------------------

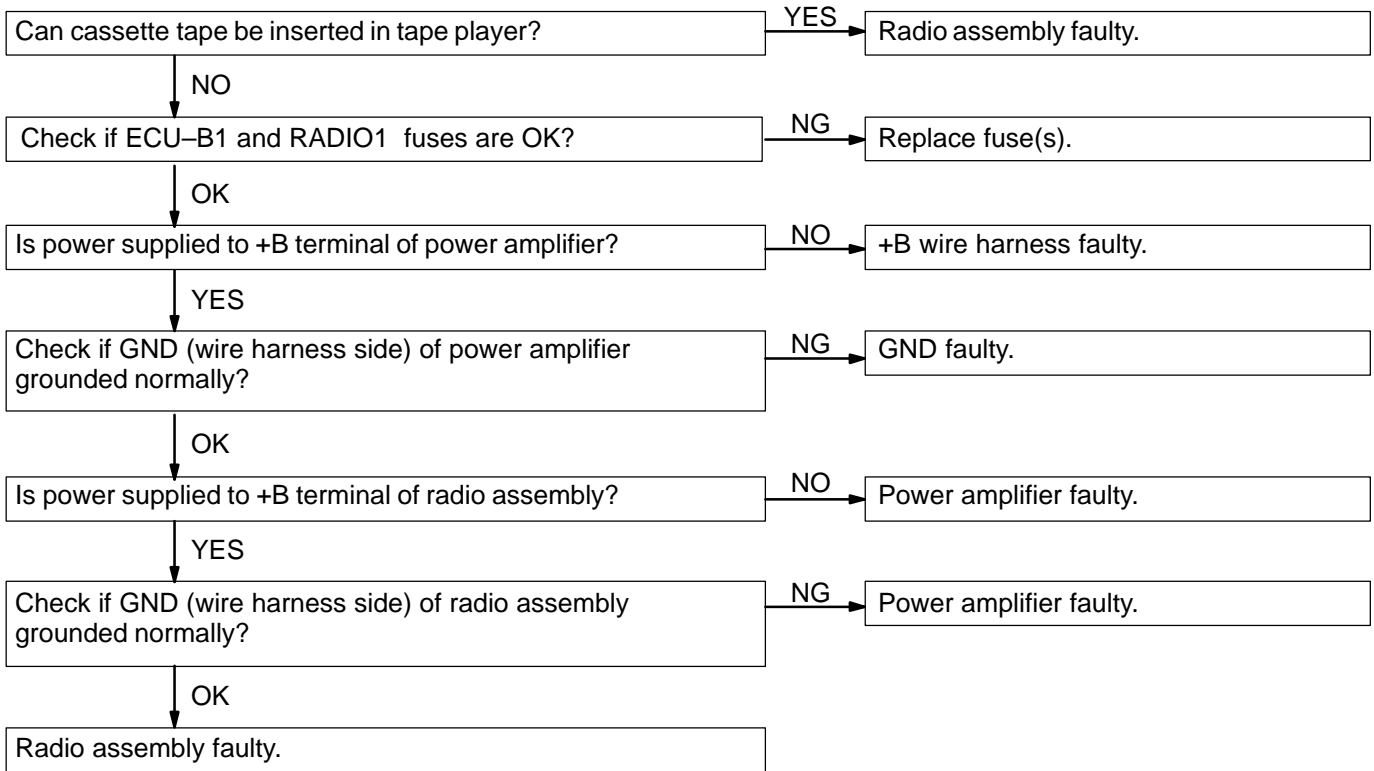

9	Tape Player	CASSETTE TAPE CANNOT BE INSERTED
----------	--------------------	---

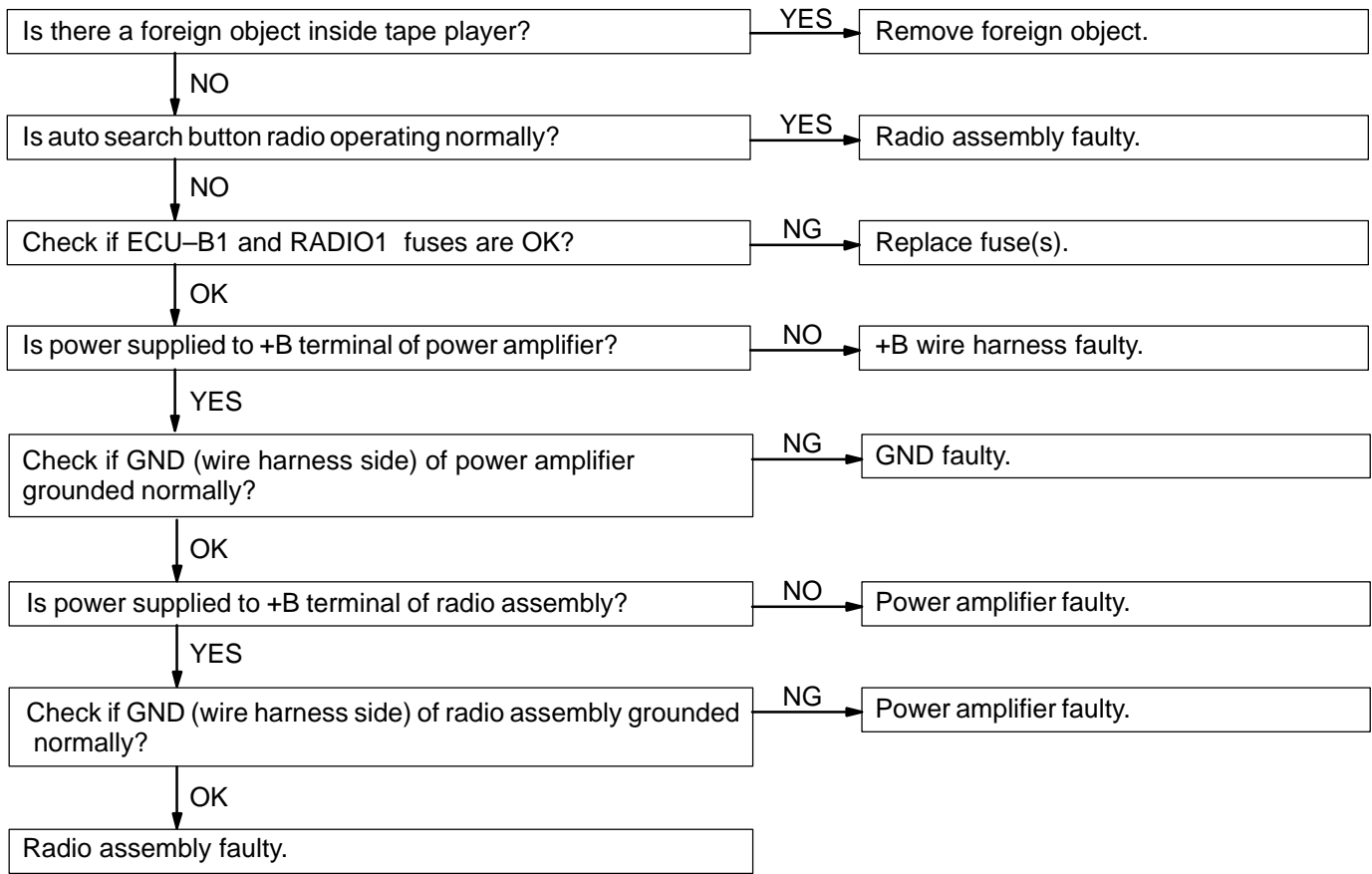

10	Tape Player	CASSETTE TAPE INSERTED, BUT NO POWER
-----------	--------------------	---

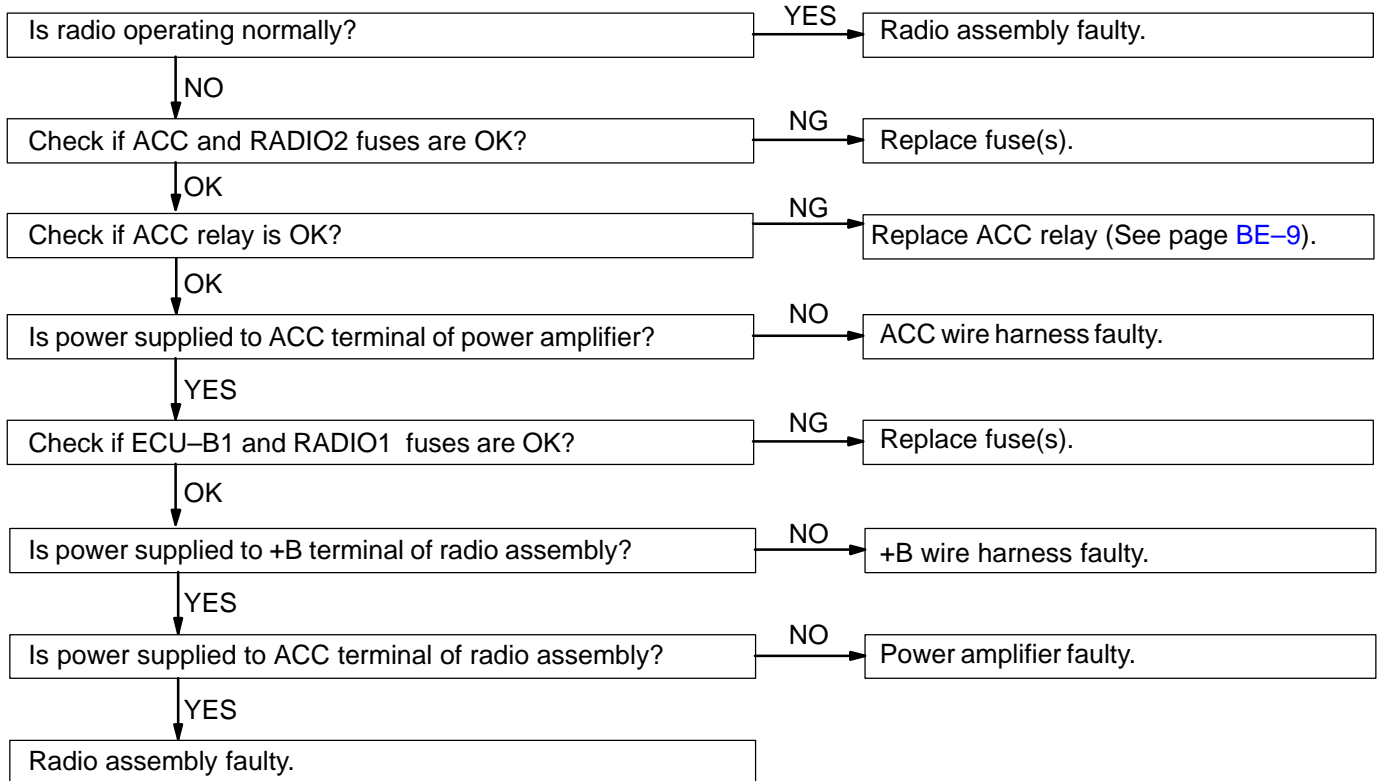

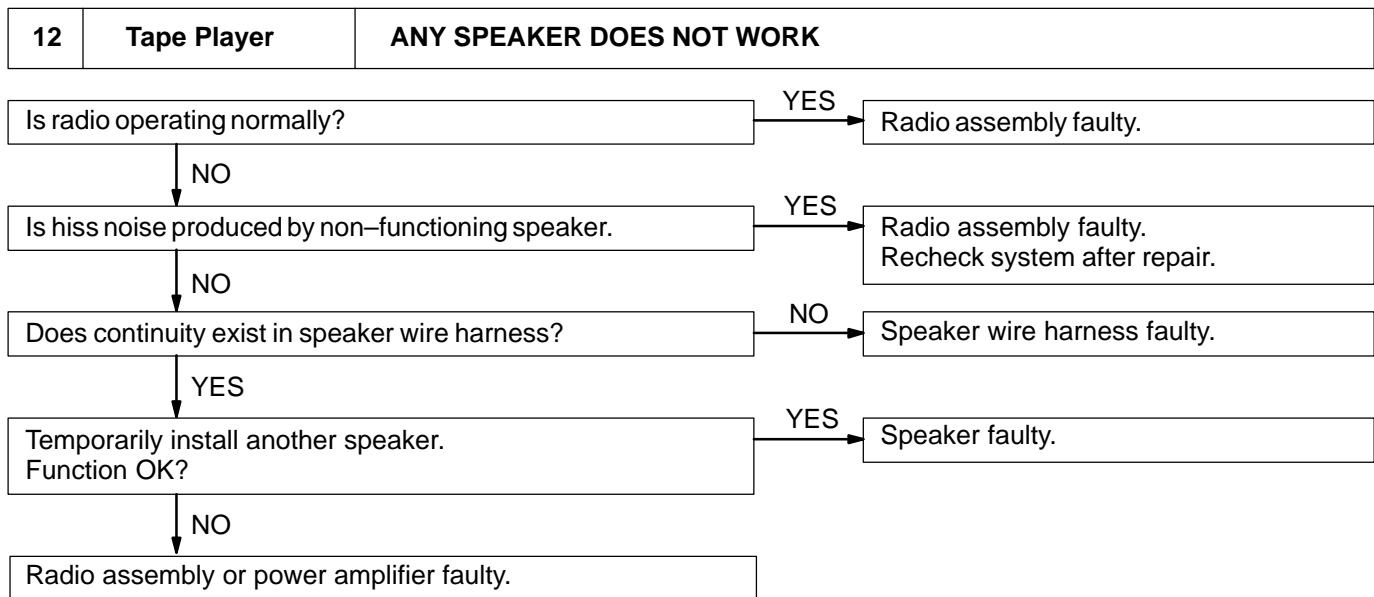
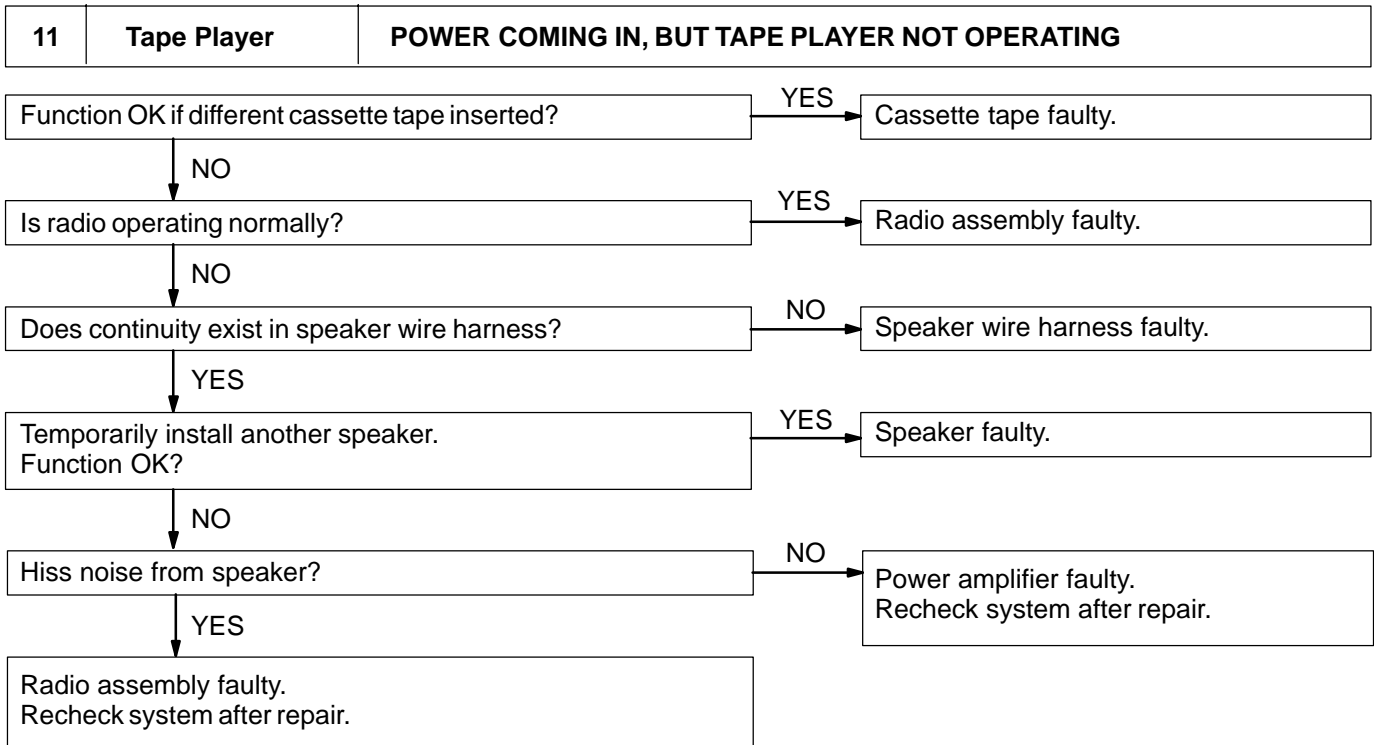

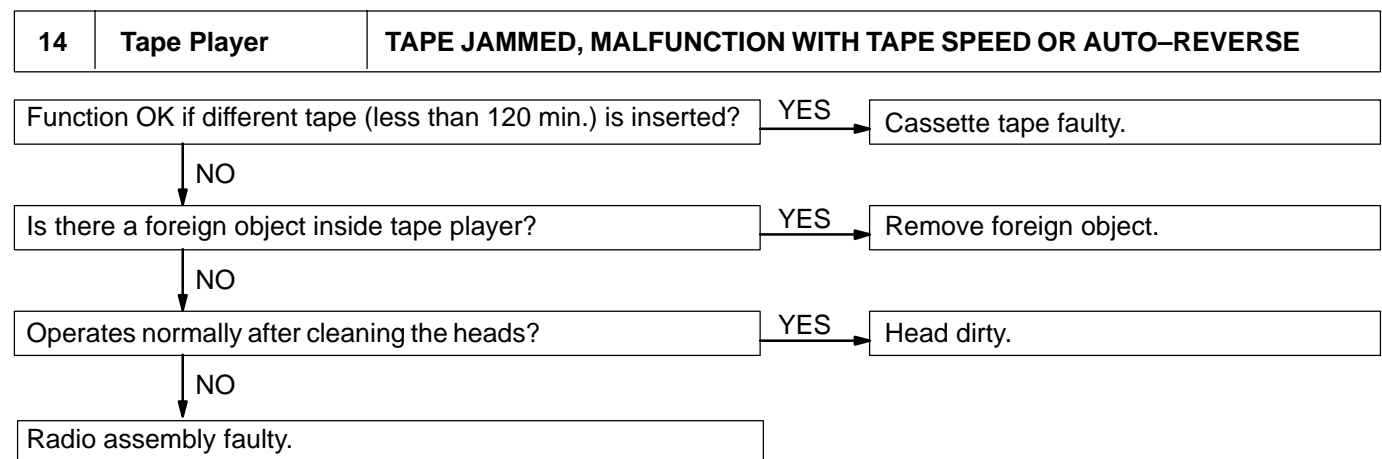
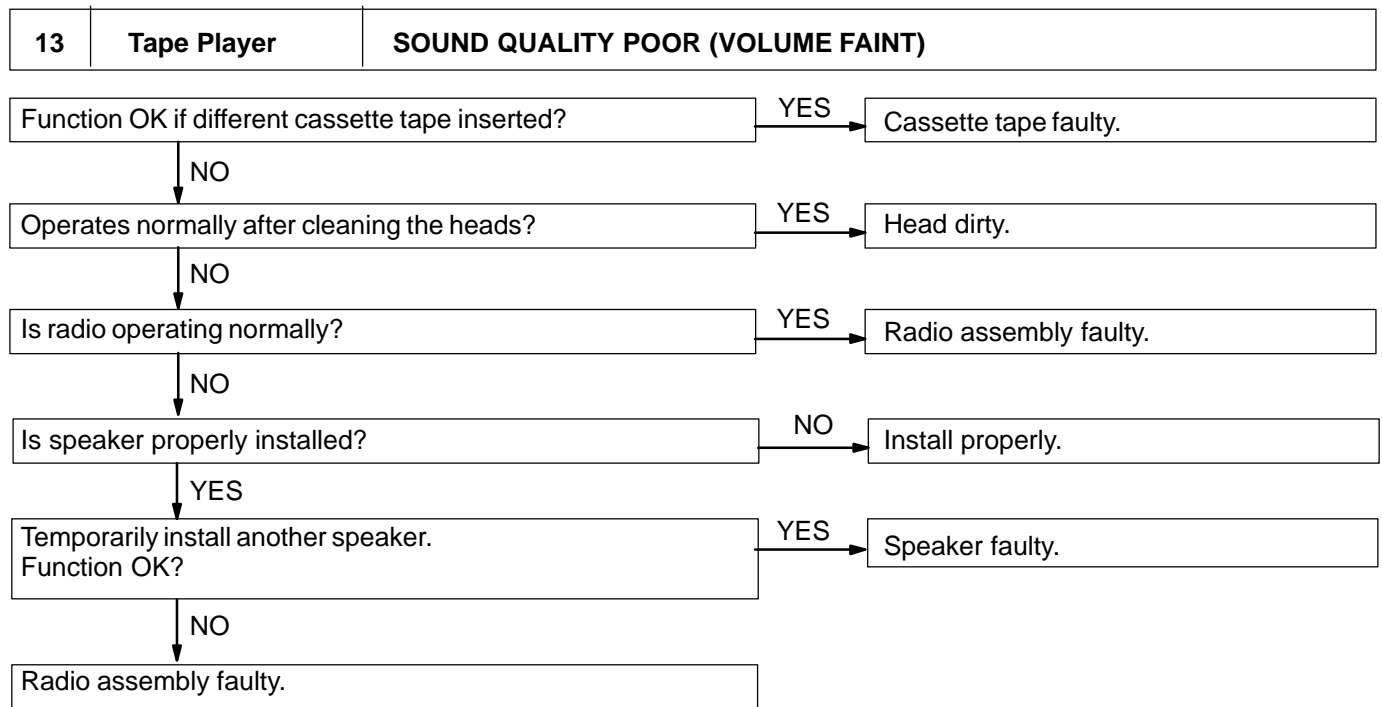

15	Tape Player	CASSETTE TAPE WILL NOT BE EJECTED
-----------	--------------------	--

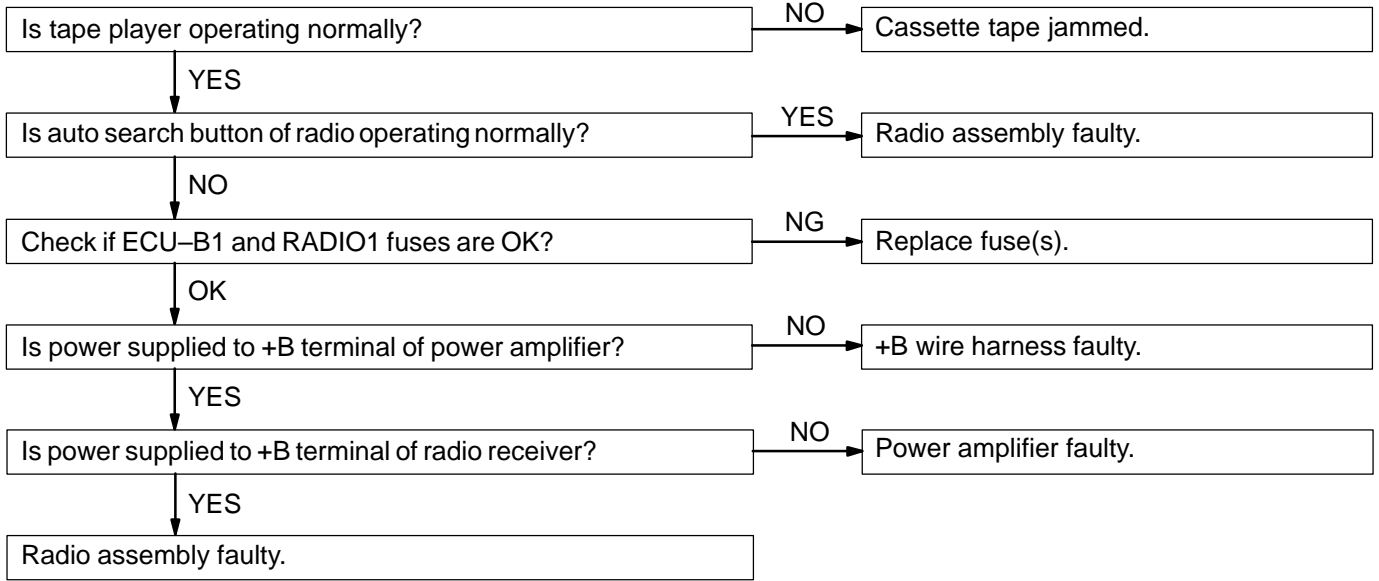

16	CD Player	CD CANNOT BE INSERTED
-----------	------------------	------------------------------

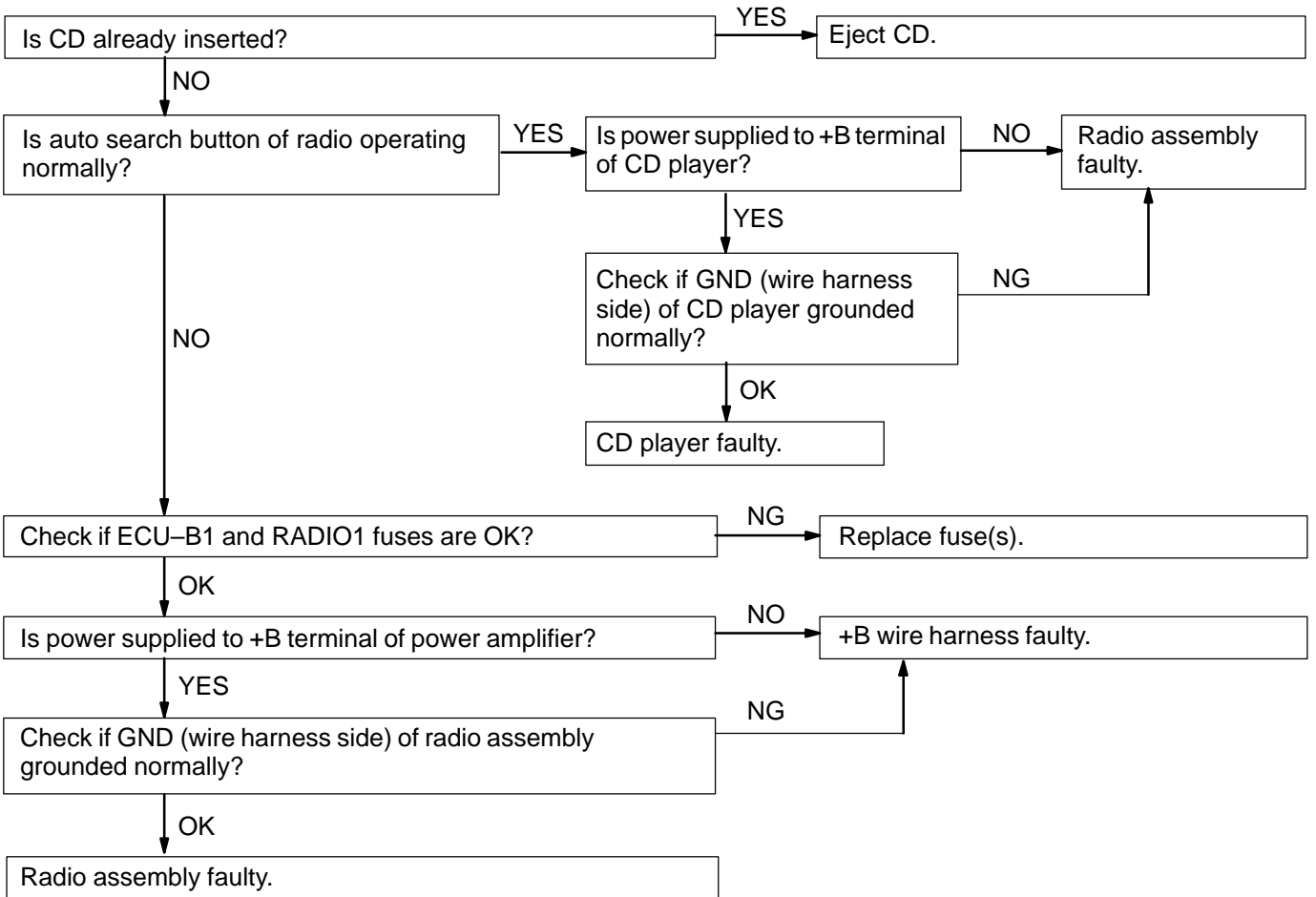

17 CD Player CD INSERTED, BUT NO POWER

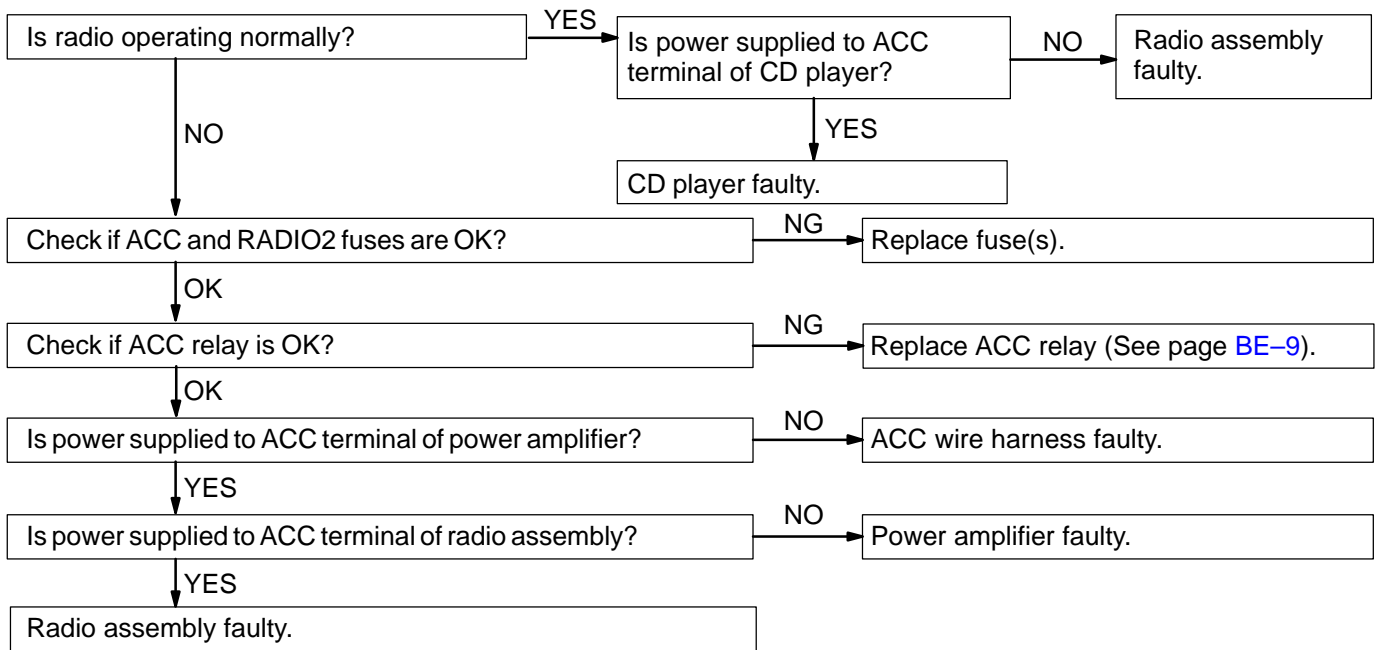

18 CD Player POWER COMING IN, BUT CD PLAYER NOT OPERATING

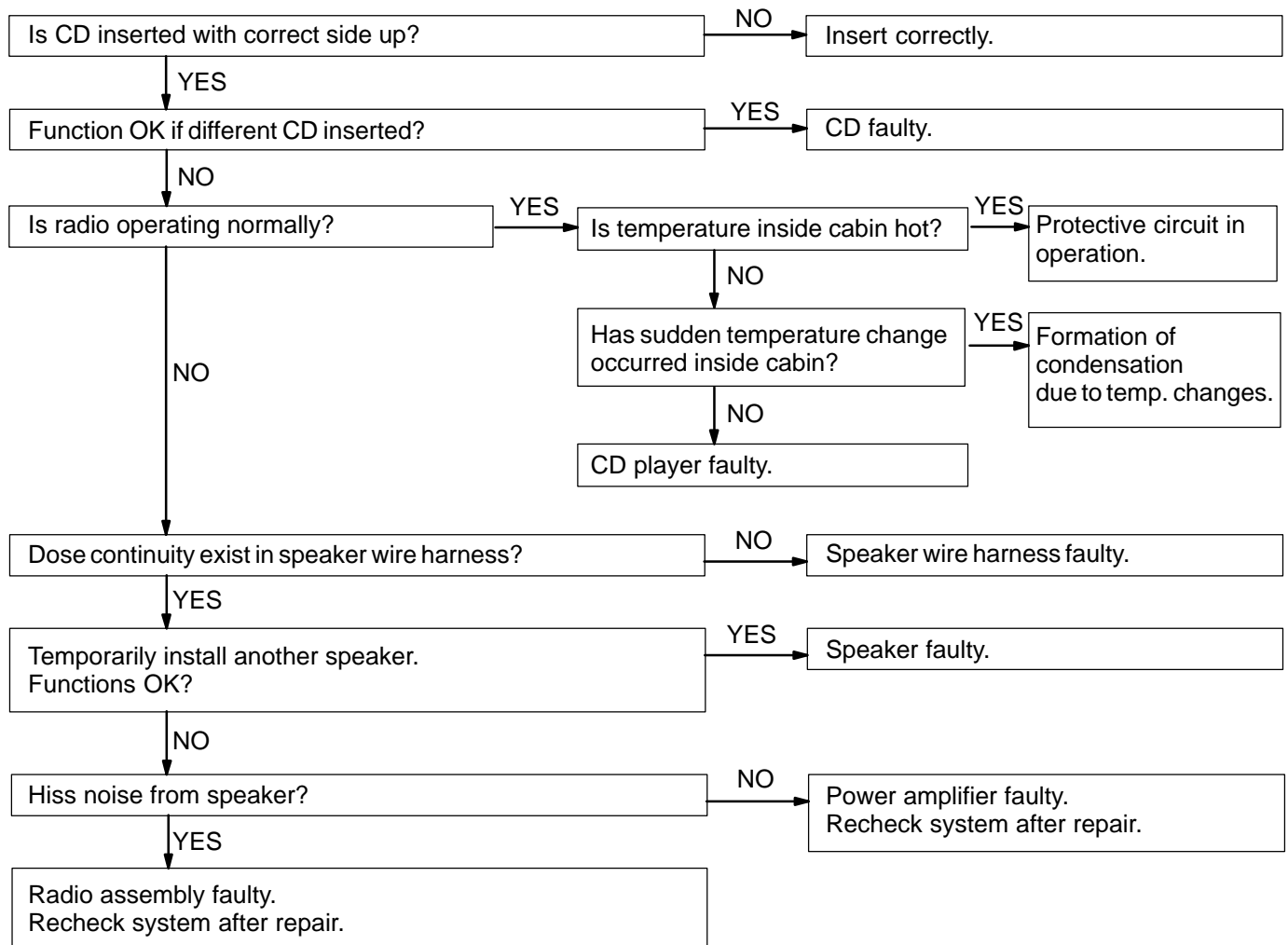

19	CD Player	SOUND JUMPS
-----------	------------------	--------------------

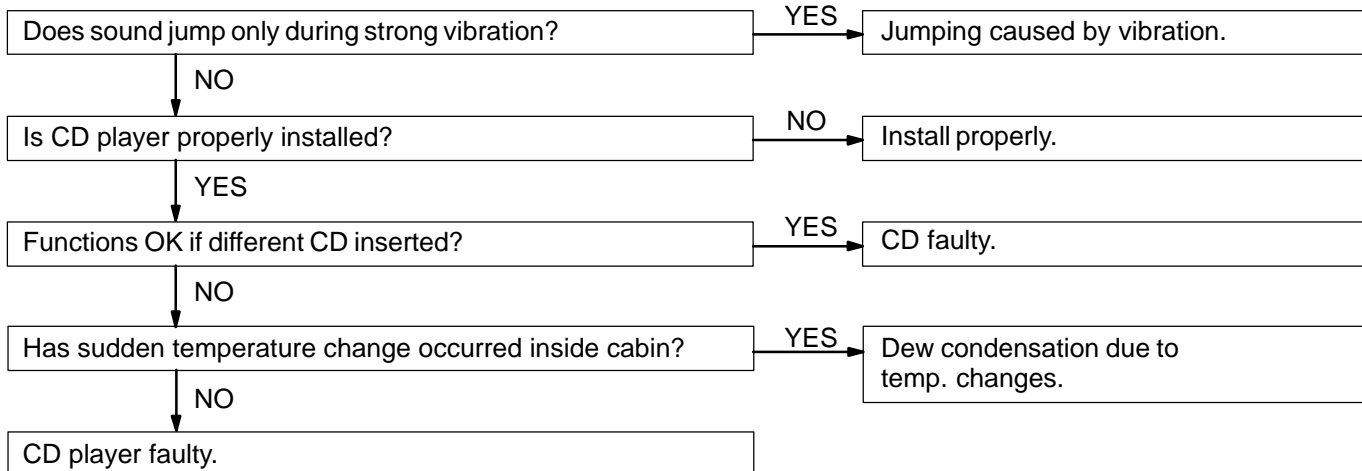

20	CD Player	SOUND QUALITY POOR (VOLUME FAINT)
-----------	------------------	--

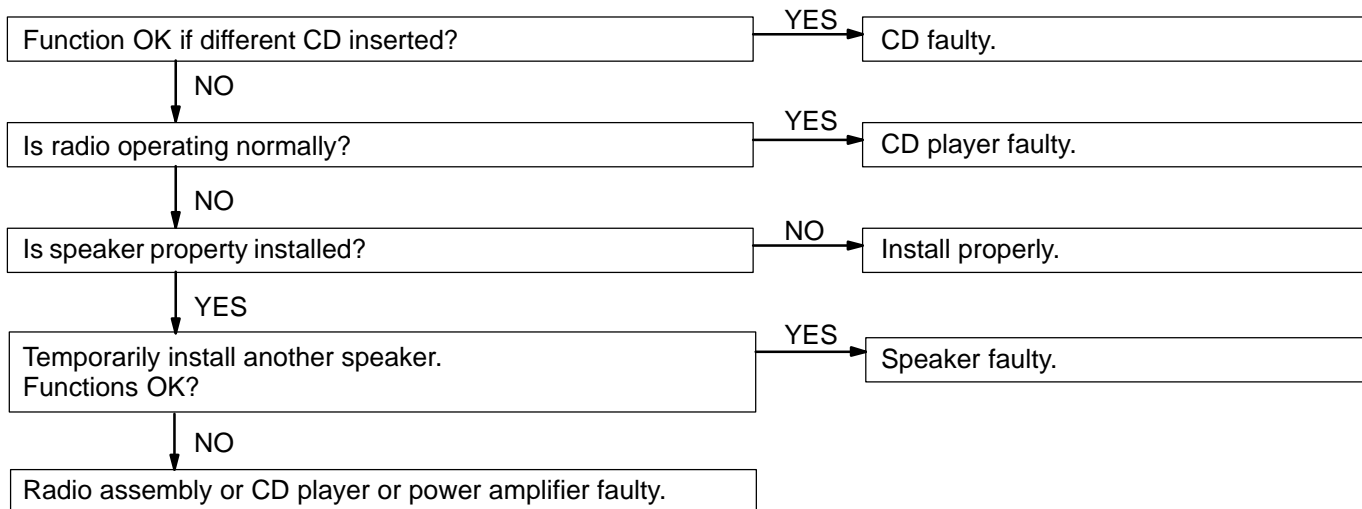

21	CD Player	ANY SPEAKER DOES NOT WORK
-----------	------------------	----------------------------------

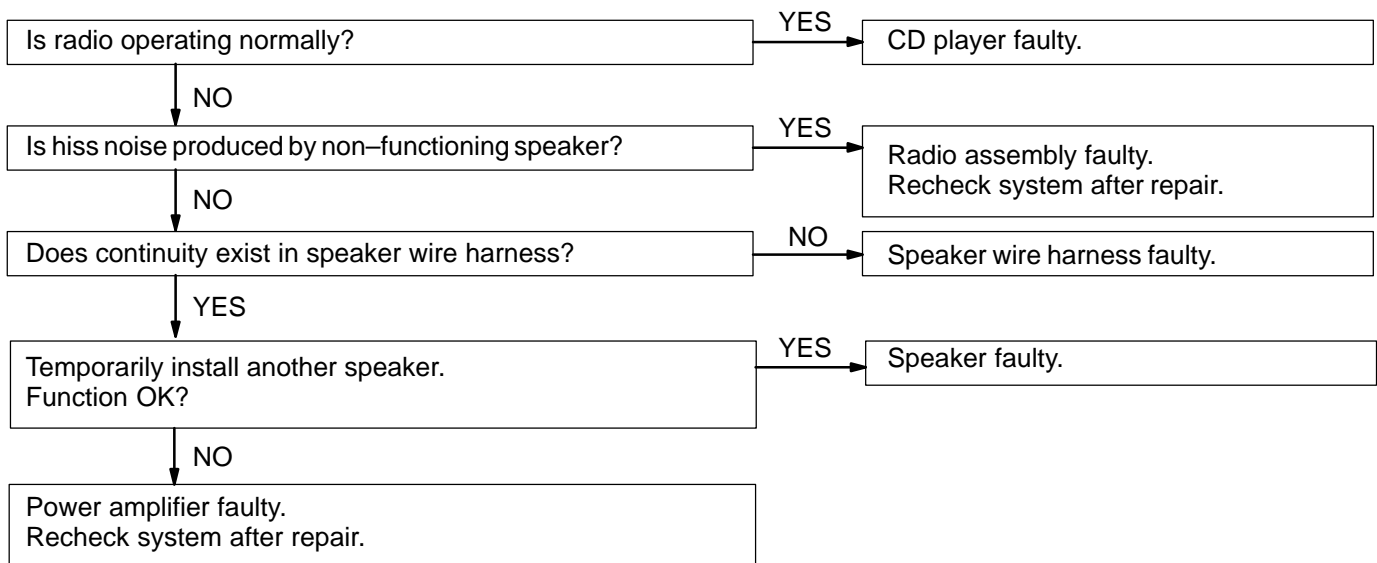

22	CD Player	CD WILL NOT BE EJECTED
-----------	------------------	-------------------------------

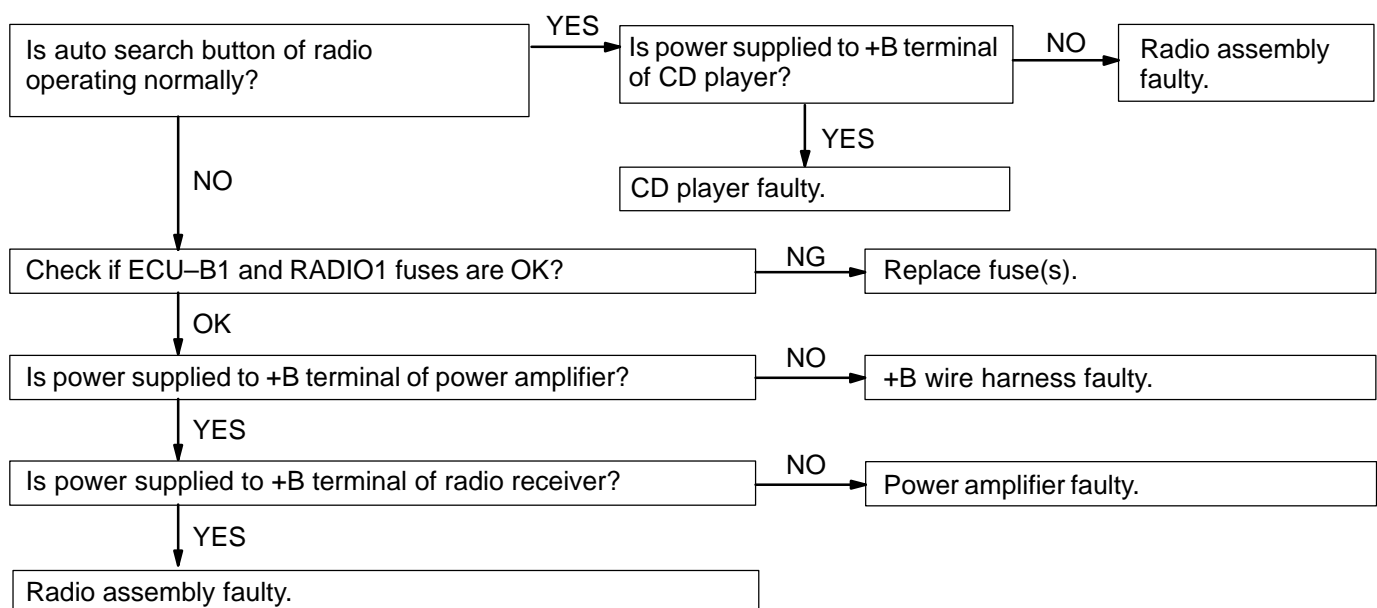

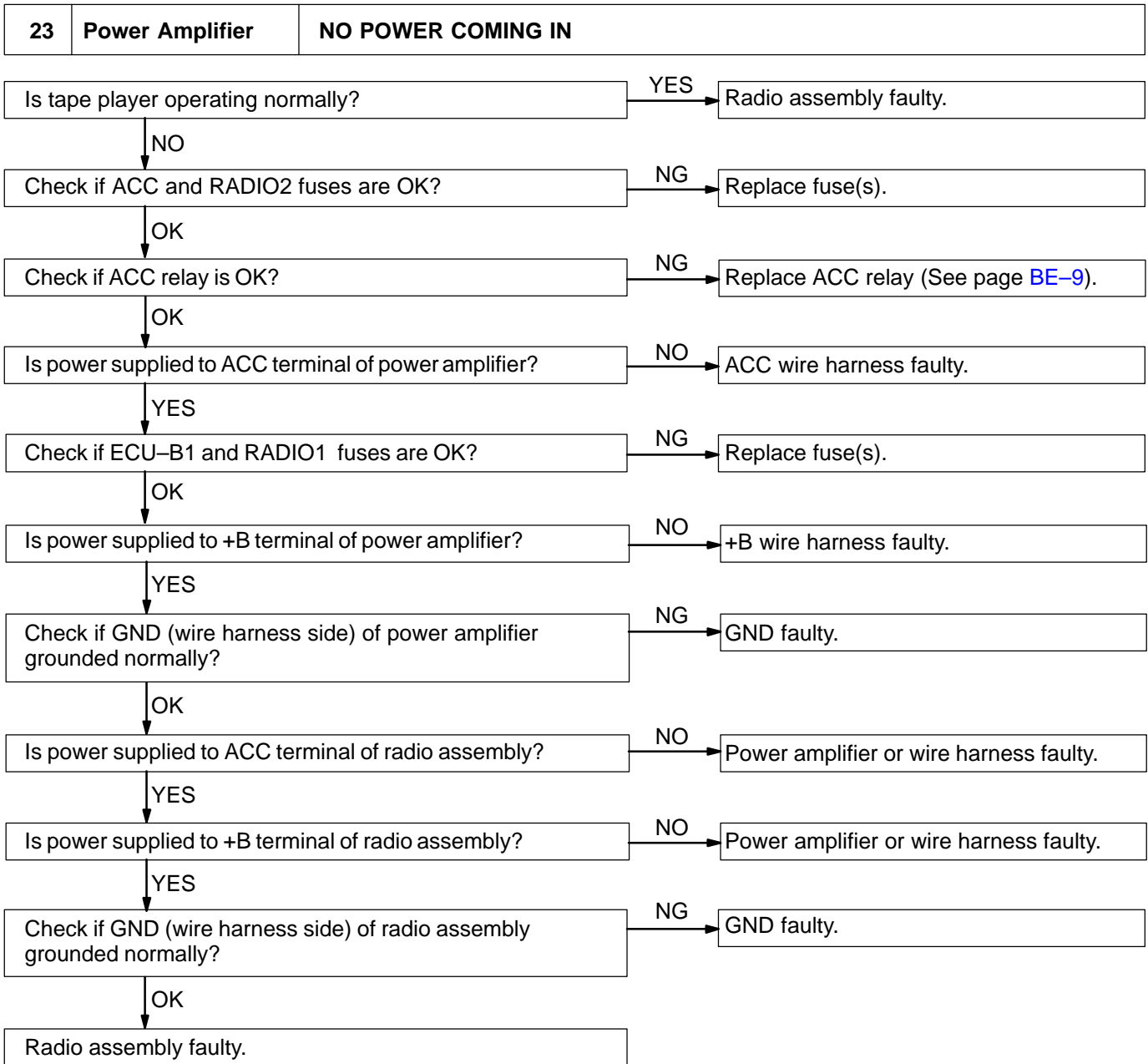

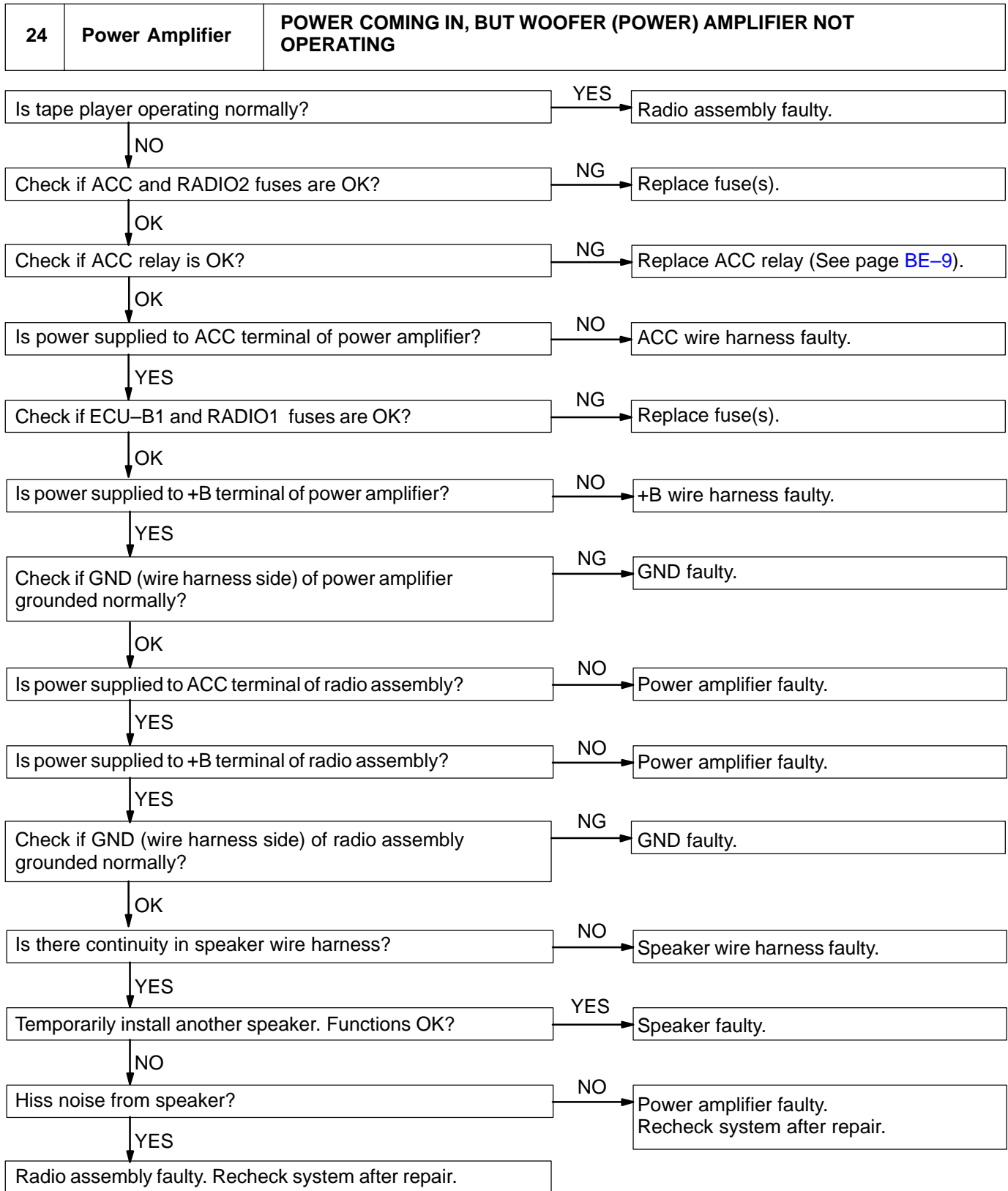

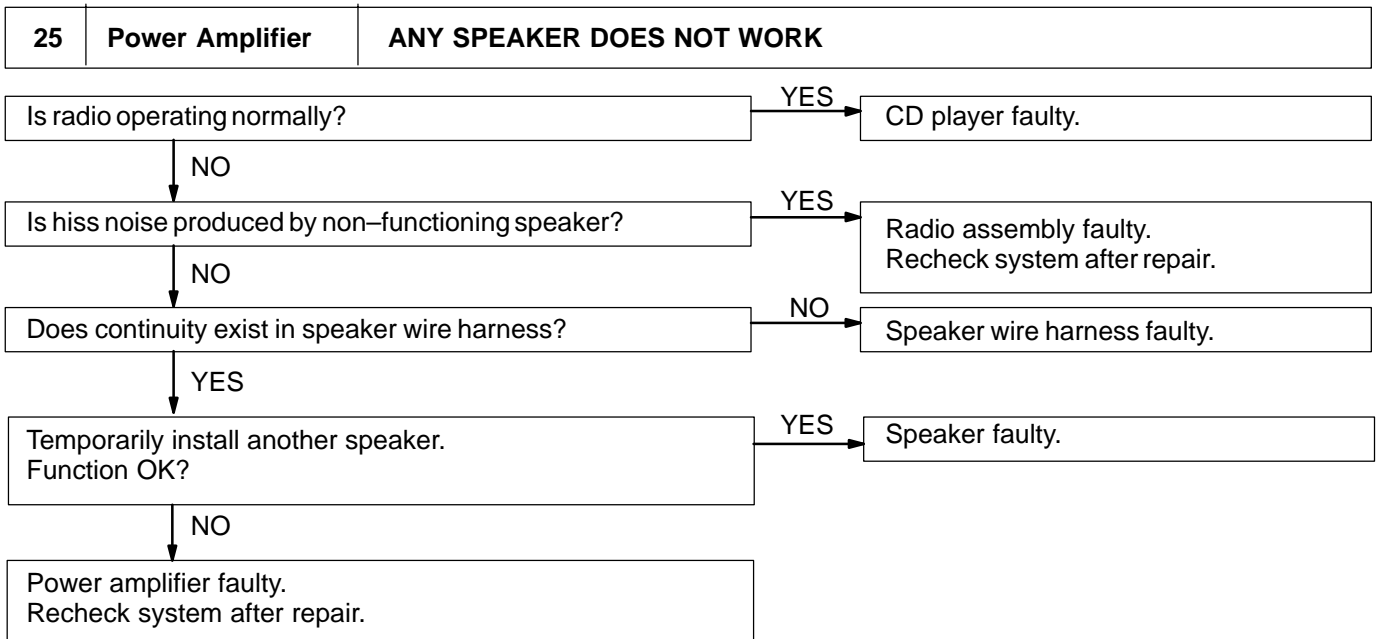

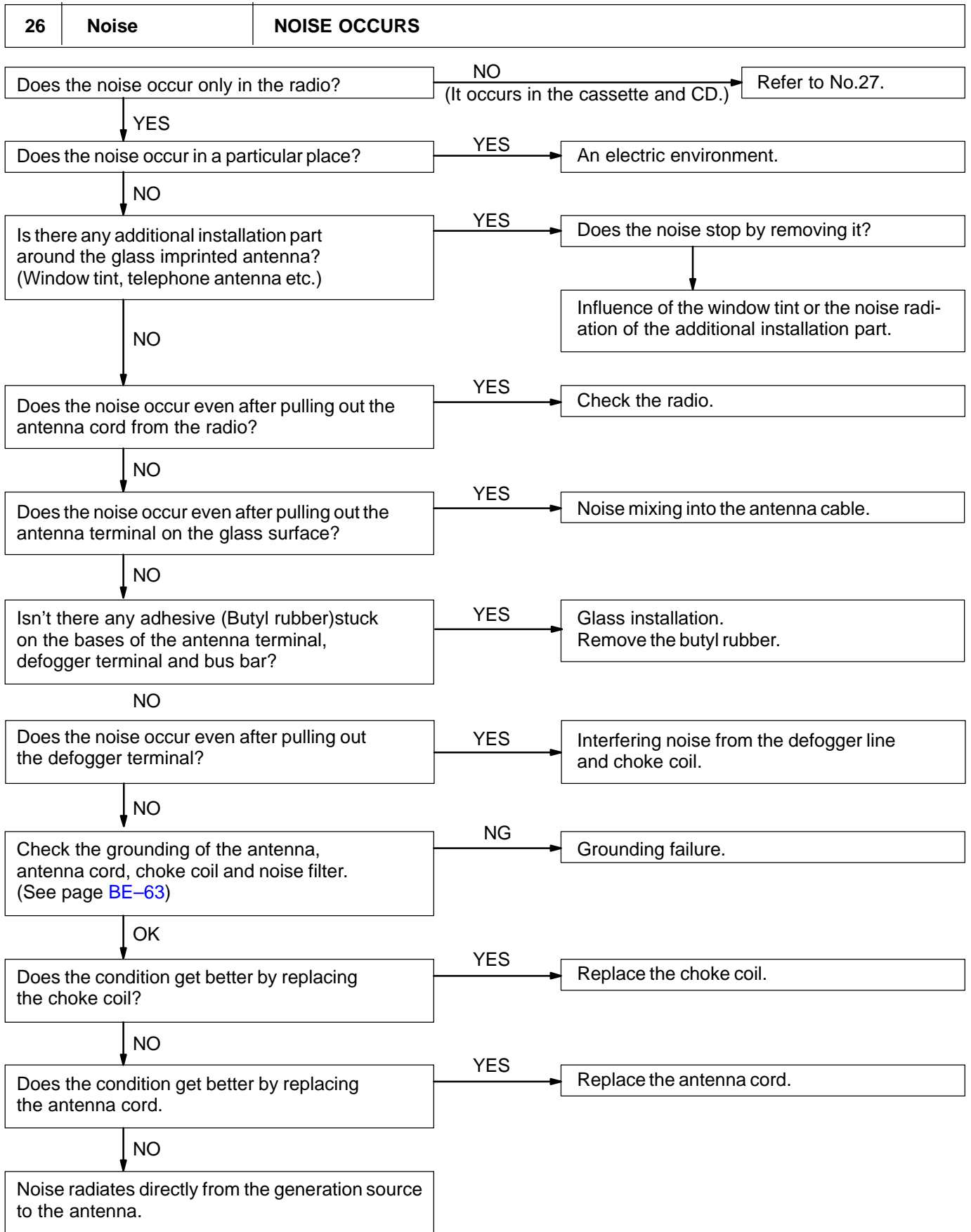

27	Noise	NOISE PRODUCED BY VIBRATION OR SHOCK WHILE DRIVING
-----------	--------------	---

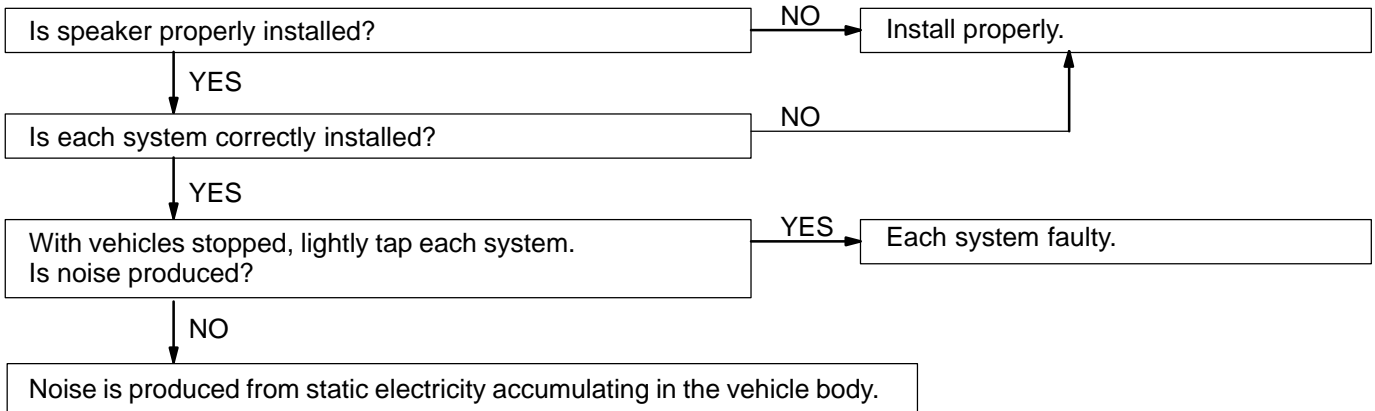

28	Noise	NOISE PRODUCED WHEN ENGINE STARTS
-----------	--------------	--

